

Problems with Your Wine Cellar

You can solve many common Wine Cellar problems easily, saving you the cost of a possible service call. Try the suggestions below to see if you can solve the problem before calling customer service.

Troubleshooting Guide

PROBLEM	POSSIBLE CAUSE
Wine Cellar does not operate.	Not plugged in. The appliance is turned off. The circuit breaker tripped or a blown fuse.
Wine Cellar is not cold enough.	Check the temperature control setting. External environment may require a higher setting. The door is opened too often. The door is not closed completely. The door gasket does not seal properly.
Turns on and off frequently.	The room temperature is hotter than normal. A large amount of contents has been added to the Wine Cellar. The door is open too often. The door is not closed completely. The temperature control is not set correctly. The door gasket does not seal properly.
The light does not work.	Not plugged in. The circuit breaker tripped or a blown fuse. The light switch is "OFF".
Vibrations.	Check to assure that the Wine Cellar is level.
The Wine Cellar seems to make too much noise.	The rattling noise may come from the flow of the refrigerant, which is normal. As each cycle ends, you may hear gurgling sounds caused by the flow of refrigerant in your Wine Cellar. Contraction and expansion of the inside walls may cause popping and crackling noises. The Wine Cellar is not level.
The door will not close properly.	The Wine Cellar is not level. The door was reversed and not properly installed. The gasket is dirty. The shelves are out of position.
Display "EL" or "EH".	The air temperature sensor is failed.

If, after checking the points made in the trouble shooting guide, the appliance is still faulty please contact the service department by telephoning 0333 247 1128.



WRWC30SS_WRWC30BK IM 24.12.2020

wren

KITCHENS

INSTRUCTION MANUAL BUILT-IN WINE CELLAR

Model No.: WRWC30SS_WRWC30BK

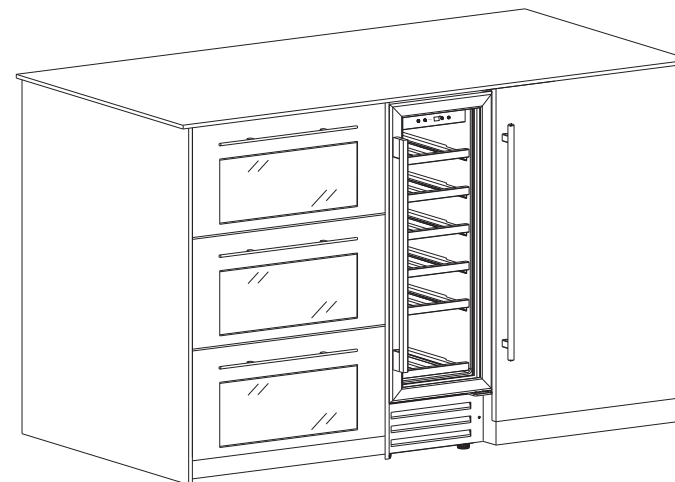

BEFORE USE, PLEASE READ AND FOLLOW ALL SAFETY RULES AND OPERATING INSTRUCTIONS.

Important Safeguards

When using an electrical appliance, basic precautions should always be followed to reduce the risk of fire, electric shock, and injury to persons, including the following:

For Your Safety

Read all instructions carefully, even if you are quite familiar with the appliance.

- The appliance is intended to be used exclusively for the storage of wine.
- Use this appliance only as described in this manual. Other uses not recommended may cause fire, electric shock or personal injury.
- This appliance is not intended for use by young children or infirm persons unless they have been adequately supervised by a responsible person to ensure that they can use the appliance safely.
- Young children should be supervised to ensure that they do not play with the appliance.
- To protect against the risk of electric shock, DO NOT IMMERSE the unit, cord, or plug in water or spray any other liquid.
- Unplug the appliance from the plug socket when not in use, when moving from one location to another and before cleaning.
- To disconnect the appliance, grip the plug and pull it from the wall outlet. Never pull by the cord.
- Do not operate the appliance in the presence of explosive and/or flammable fumes.
- Do not place the appliance or any of its part near an open flame, cooking or other heating appliance.
- Do not operate the appliance with a damage cord or plug, if the product malfunctions, or if it is dropped or damaged in any manner.
- The use of attachments not recommended by the manufacturer may be hazardous.
- Place the unit on a dry level surface.
- Do not operate if the housing is removed or damaged.
- A loose fit between the AC outlet (receptacle) and plug may cause overheating and a distortion of the plug. Contact a qualified electrician to replace loose or worn outlet.
- Locate the unit away from direct sunlight and sources of heat (stove, heater, radiator, etc.).
- This appliance is CFC- and HFC-free and contains small quantities of Isobutane (R600a), an environmentally friendly coolant.
- You must ensure that the cooling circuit is undamaged when installing the appliance. However, if it becomes damaged, avoid proximity to open fires and heat sources of all kinds. The room in which the appliance is located should be ventilated for a few minutes.
- Never use an appliance with a damaged circuit.
- Ensure that the ventilation openings to and from a built-in appliance are never blocked or covered. No liability will be accepted for any damage incurred owing to misuse of the appliance or as a result of repairs carried out by unqualified personnel. In this case neither the guarantee nor any other liability claims will apply.
- **WARNING:** Do not operate any electrical appliance inside the appliance.
- Do not attempt to repair or replace any part of your appliance unless it is specifically recommended in this manual. All other servicing should be referred to a qualified technician.
- Replace all panels after service before operating.
- Use two or more people to move and install the appliance. Failure to do so can result in back or other injury.
- Never clean appliance parts with flammable fluids. These fumes can create a fire hazard or explosion. And do not store or use gasoline or other flammable vapors and liquids in the vicinity

Care and Maintenance

Removing Shelves

- To remove any of the shelves from the rail compartment, move the shelf to the position where the notch of wooden shelf is exactly under the plastic post and lift the wooden shelf. Please ensure these are replaced when the shelf is put back.

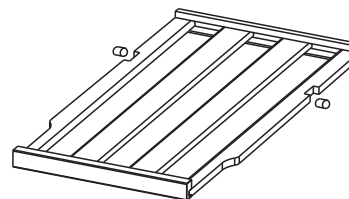

Humidity Control

- The wine cellar is equipped with a system for maintaining the correct level of humidity. Fill the small plastic reservoir (humidity box) $\frac{3}{4}$ full with water, and fit onto the runners found on the top shelf of the wine cellar. Check the water level regularly and refill as necessary.
- Please ensure the reservoir is positioned correctly on the runners on the top shelf to avoid the possibility of water spillage.

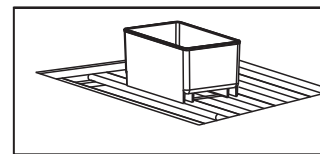

Cleaning Your Wine Cellar

- Turn off the power, unplug the appliance, and remove all items including shelves and rack.
- Wash the inside surfaces with a warm water and baking soda solution. The solution should be about 2 tablespoons of baking soda to a pint of water.
- Wash the shelves with a mild detergent solution.
- Wring excess water out of the sponge or cloth

when cleaning any area of the controls.

- Wash the outside cabinet with warm water and mild liquid detergent. Rinse well and wipe dry with a clean soft cloth.

Power Failure

- Most power failures are corrected within a few hours and should not affect the temperature of your appliance if you minimize the number of times the door is opened. If the power is going to be off for a longer period of time, you need to take the proper steps to protect your contents.

Vacation Time

- **Short holidays:** Leave the Wine Cellar in operation for holidays of less than three weeks.
- **Long absences:** If the appliance will not be used for several months, remove all items, turn off the appliance and unplug. Clean and dry the interior thoroughly. To prevent odour and mold growth, leave the door open slightly: blocking it open if necessary.

Moving Your Wine Cellar

- Remove all items.
- Securely tape down all loose items (shelves) inside your appliance.
- Turn the adjustable leg up to the base to avoid damage.
- Tape the door shut.
- Be sure the appliance stays secure in the upright position during transportation. Also protect outside of appliance with a blanket, or similar item.

Energy Saving Tips

- The Wine Cellar should be located in the coolest area of the room, away from heat producing appliances, and out of the direct sunlight.
- Ensure that the unit is adequately ventilated. Never cover air vents.
- Only open the door for as long as necessary.

holding the **DOWN** mark for at least 5 seconds and you can hear “B B B B” five sounds and the unit will work in Dynamic Cooling mode.

Shelves

- To prevent damaging the door gasket, make sure the door is fully open when pulling shelves out of the rail compartment.
- For easy access to the bottles stored, pull the shelves out approximately 1/3. The shelves are designed with an emergency stop to prevent them being removed too far when loaded.

Defrosting

- The unit defrosts automatically.
- The evaporator behind the rear wall of the unit defrosts automatically. The condensate collects in the drainage channel behind the rear wall of the unit, and flows through the drainage hole into the drip tray above the compressor where it evaporates.

of this or any other appliance. The fumes can create a fire hazard or explosion.

- Do not connect or disconnect the electric plug when your hands are wet.
- It is recommended that a separate circuit, serving only your appliance be provided. Use receptacles that cannot be turned off by a switch or pull chain.
-

WARNING: To reduce the risk of fire, electric shock or personal injury, unplug or disconnect the appliance from the power supply before servicing.

Save These Instructions

If you are experiencing problems, check the Troubleshooting Guide at the back of this manual. It lists causes of minor operating problems that you can correct yourself.

Disposal of Old Appliance

Dispose of your appliance packaging properly.

Refrigeration equipment must be properly disposed of in a way which protects the environment. This applies to your old appliance and to your new unit once it has reached the end of its service life.

WARNING: Please ensure that old, worn appliances are rendered unusable before disposal by removing the plug, cutting the network cable, and removing or destroying any snap fastenings or bolts. You will thus prevent children from locking themselves in the appliance during play (risk of suffocation) or endangering their lives in any other way.

Disposal instructions:

- The appliance must not be disposed of in the dustbin or with normal household rubbish.
- The coolant circuit, particularly the heat exchanger at the back/bottom of the unit, must not be damaged.
- The  symbol on the product or its packaging

indicates that this product is not to be handled as normal household waste but is to be taken to a recycling collection point for electrical and electronic goods. By correctly disposing of this product you are contributing to the protection of the environment and to the health of your fellow human beings. Improper disposal endangers health and the environment. Further information about the recycling of the product may be obtained from your town hall, refuse collection department or the store where you purchased the product.

Connection to the Mains Supply

Check that the voltage marked on the product corresponds with your supply voltage.

This product is fitted with a 13A plug complying with BS1363. If this plug is unsuitable or needs to be replaced, please note the following:

WARNING:
THIS APPLIANCE MUST BE EARTHED.

Important: The wires in the mains lead are coloured in accordance with the following code:

GREEN/YELLOW - EARTH
BLUE - NEUTRAL
BROWN - LIVE

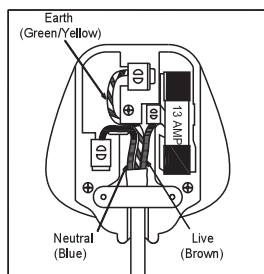

This appliance is equipped with a plug fitted with a 13 amp fuse. Should the fuse fail, then it must be replaced with an ASTA approved fuse (conforming to BS1362) of the same rating. If you need to replace the plug or if the plug is of the incorrect type for your socket, remove it and replace it with an appropriate type. Dispose of the old plug safely.

As the colors of the wires in the mains lead of this appliance may not correspond with the colored markings identifying the terminals in your plug, proceed as follows: The **GREEN/YELLOW** wire is the **EARTH** and must be connected to the terminal which is marked with the letter 'E' or by the earth symbol  or colored **GREEN** or **GREEN/YELLOW**.

The **BLUE** wire is the **NEUTRAL** and must be connected to the terminal which is marked with the letter 'N' or colored **BLACK**.

The **BROWN** wire is the **LIVE** wire and must be connected to the terminal which is marked with the Letter 'L' or colored **RED**.

Always ensure that the plug cord grip is fastened correctly.

If in doubt consult a qualified electrician who will be pleased to do this for you. This product conforms to EC Directive 92/31 /EEC with respect to Electromagnetic Compatibility.

NON-REWIREABLE MAINS PLUG

If your appliance is supplied with a nonrewireable plug fitted to the mains lead, you will find that it incorporates a fuse, the value of which is indicated either on the base of the plug or on the fuse carrier. Should the fuse need replacing, you must use an ASTA approved one (conforming to BS1362) of the same rating.

If the fuse cover is lost, the plug must not be used until a replacement is obtained from an electrical supplier.

If you need to remove the plug, cut it from the mains lead and immediately dispose of it. Never attempt to re-use this plug or insert it into a socket outlet as there is a very great risk of an electric shock.



Operating Your Wine Cellar

The Wine Cellar should be placed in a position where the ambient temperature is between 16-32°C. If the ambient temperature is above or below this range, the performance of the unit may be affected. For example, placing your unit in extreme cold or hot conditions may cause interior temperatures to fluctuate. The range of 5-22°C may not be reached.

Note:

- When you use the Wine Cellar for the first time or restart the Wine Cellar after having been shut off for a long time, there could be a few degrees variance between the temperature you select and the one indicated on the LED readout. This is normal and it is due to the length of the activation time. Once the Wine Cellar is running for a few hours everything will be back to normal.
- If the unit is unplugged, power lost, or turned off, you must wait 3 to 5 minutes before restarting the unit. If you attempt to restart before this time delay, the Wine Cellar will not start.

The Controls of Your Wine Cellar



POWER

To control this appliance turn on/off. To turn OFF the appliance, touch the  mark and hold 5 seconds.

LIGHT

To control the inner light turn on/off.

UP

Used to raise (warm) the set temperature by 1°C.

DOWN

Used to lower (cool) the set temperature by 1°C.

°F/°C Selector

Select the temperature display setting in Fahrenheit or Celsius degree. To change the temperature from Fahrenheit to Celsius or from Celsius to Fahrenheit, press the  button for 5 seconds.

Setting the Temperature Control

- You can set the temperature as required by touching the **UP** or **DOWN** mark. When you touch the two marks for the first time, the LED readout will show the original temperature set previously (the temperature preset at the factory is 12°C).
- The temperature will increase 1°C if you touch the **UP** mark once, or the temperature will decrease 1°C if you touch the **DOWN** mark once.
- To view the "set" temperature at any time, touch the **UP** or **DOWN** mark, the "set" temperature will temporarily "flash" in the LED display for 5 seconds.

Temperature Display

During normal operation, the temperature display on the control panel shows the temperature inside the appliance.

Reversing the Door Swing of Your Appliance

Should you desire to reverse the opening direction, please follow the instructions below.

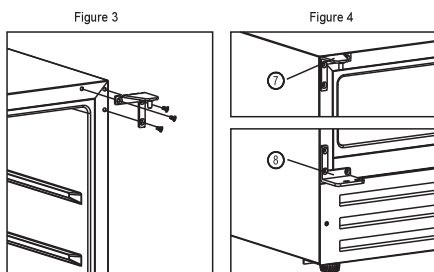
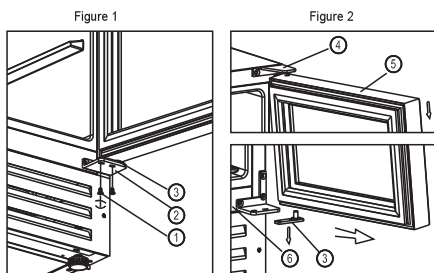

- | | |
|-----------------------|--------------------|
| ① Lock Screws | ⑤ Door |
| ② Right Lower Hinge | ⑥ Cabinet |
| ③ Door Shaft Assembly | ⑦ Left Top Hinge |
| ④ Right Top Hinge | ⑧ Left Lower Hinge |

Note: All parts removed must be saved to do the reinstallation of door.

1. Open the glass door and remove the two screws under the right bottom corner of the glass door that are used to hold the right lower hinge to the door shaft assembly. Be careful to support the glass door with hands to prevent it dropping after removing the screws. (Figure 1)
2. Pull down to remove the glass door and place it on a padded surface to prevent scratching it. (Figure 2)
3. Remove the right top hinge and right lower

hinge. (Figure 3). Remove the left top hinge and left lower hinge from the plastic bag that includes the instruction manual then install them at the designated positions at the left side of cabinet. (Figure 4)

4. Turn around the glass door 180° and reinstall it.

Features of Your Wine Cellar

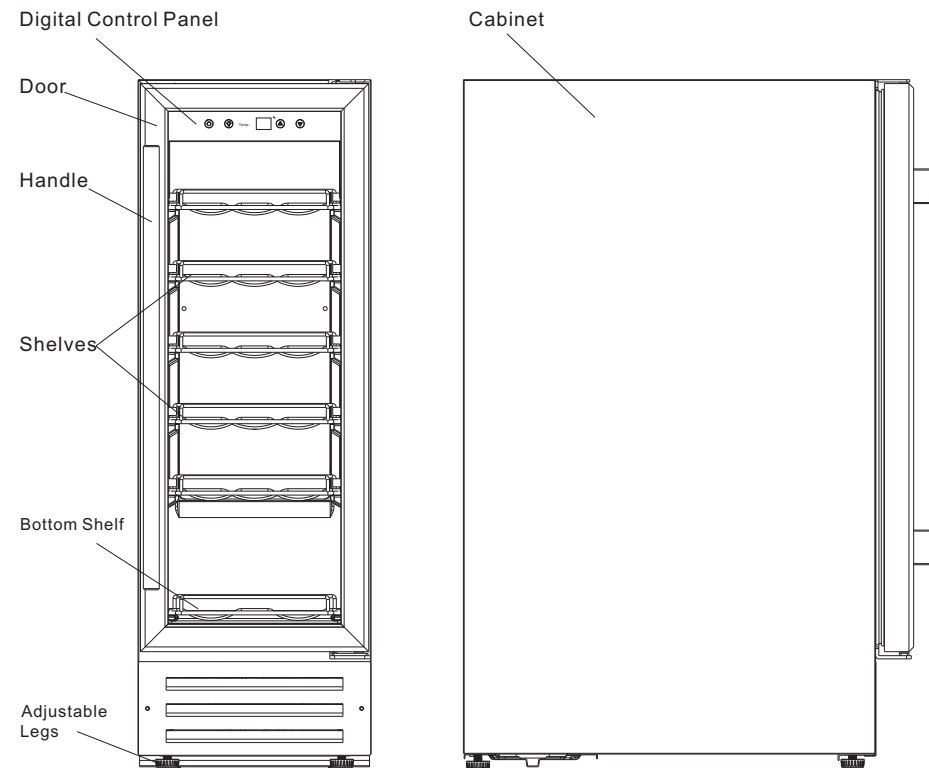

Installation Instructions

Before Using Your Wine Cellar

- Remove all exterior and interior packing.
- Before connecting the Wine Cellar to the power source, let it stand upright for approximately 2 hours.
- This will reduce the possibility of a malfunction in the cooling system caused by handling during transportation.
- Clean the interior surface with lukewarm water using a soft cloth.
- The door on this appliance can be opened from either the left or the right side. The unit is delivered with the door opening on the left side. Should you wish to open the door from the right, follow the instructions 'Reversing the door swing of your appliance'.

Installation of Your Wine Cellar

- The appliance is designed to be built in between kitchen cabinets and is supplied with adjustable feet that can be altered to fit various worktop heights. This wine cellar is fully compatible with any 600mm deep kitchen unit.
- Place your Wine Cellar on a floor that is strong enough to support it when it is fully loaded. To level your Wine Cellar, adjust the front leveling leg at the bottom of the Wine Cellar.
- Locate the Wine Cellar away from direct sunlight and sources of heat (stove, heater, radiator, etc.). Direct sunlight may affect the acrylic coating and heat sources may increase electrical consumption. Extreme cold ambient temperatures may also cause the unit not to perform properly.
- Avoid locating the unit in damp areas.
- Plug the Wine Cellar into an exclusive, easily accessible plug socket. Any questions concerning power and/or earthing should be directed towards a qualified electrician or an authorized products service centre.
- The air vent at the front of the appliance must never be covered or blocked in any way.
- The appliance must be installed to all electrical, plumbing, water and drain connections in

accordance with state and local codes.

- IMPORTANT: HIGH HUMID CLIMATE.** During periods of high humidity, some condensation may appear on outside surfaces of glass door. This condensation will disappear when humidity levels drop. For prevention, it is advisable to install the appliance with sufficient ventilation in a dry and/or an air-conditioned place.

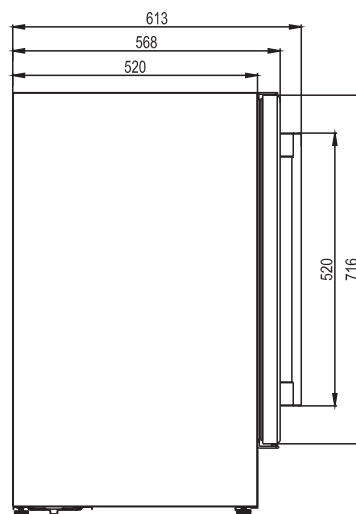
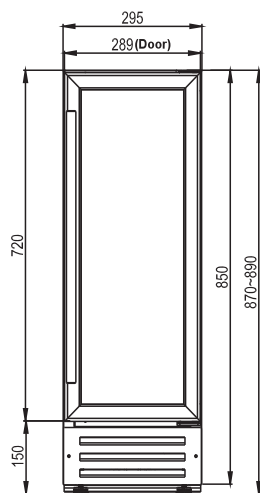

Built-in Cabinet Instructions

This unit is designed for both built-in or free standing installation. If you plan to use this unit in a built-in application please follow the requirements shown to the below.

Cabinet Opening Dimensions	
	MM (min)
Width	300 mm
Depth	600 mm
Height	875 mm

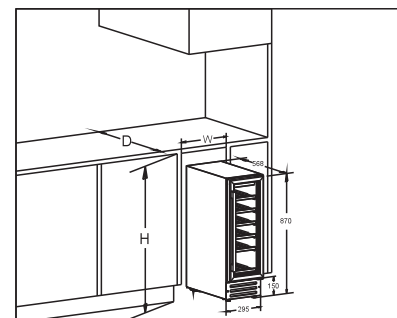

Use Attention

- Store wine in sealed bottles.
- Do not overload the cabinet.
- Do not open the door unless necessary.
- Do not cover shelves with aluminum foil or any other shelf material which may prevent air circulation.
- Should the wine cellar be left empty for long periods it is suggested that the appliance is unplugged, and after careful cleaning, leave the door ajar to allow air to circulate inside the cabinet in order to avoid possible condensation, mold or odours forming.

Installing the Handle

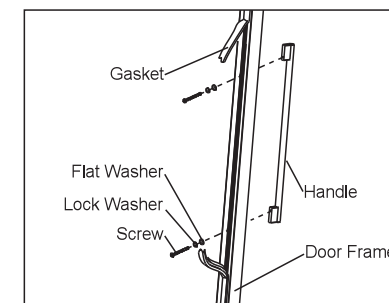

- Remove the door gasket on the side you wish to install the handle - you can see two designated holes for handle installation.
- Install the handle tightly as shown above with two screws, lock washers and flat washers provided.
- Replace the door gasket.